

12.11.2021

## ROBE GDTF files library update

### Products Involved

[iBar 15™](#) [FORTE®](#) [FORTE® FS](#) [DL4X Spot™](#) [iSpiider®](#) [iPointe65®](#) [CUETE®](#) [T2 Fresnel™](#)  
[T2 PC™](#) [iParFect 150™](#) [FW RGBW](#)

Our technical team at Robe, together with a Robe dedicated GDTF (General Device Type Format) in house library maintainer, has been working on ensuring that when new products are released, correct GDTF file is made available for controlling, visualization or planning.

Read on for more details.

After starting the GDTF initiative in 2018 as a member of the GDTF group, we have been focusing on providing specification and tools for convenient creation of the General Device Type Format files. You can read more about this innovative format in our [dedicated GDTF page](#).

If you are interested in the GDTF Specification, you can find it in the form of [DIN SPEC 15800 here](#). GDTF Builder (a tool to create GDTF files) is also publicly [available online](#) to anyone. ROBE GDTF files library is available [here on a dedicated page](#).

The screenshot shows the 'PhysicalDescriptions' tab of the GDTF Builder. On the left, a list of filters is shown under the 'Filters' tab, including Cyan, Magenta, Yellow, CTO 2700, Deep red, Deep blue, Orange, Green, Congo blue, Multicolor, Laser green, Lavender, Filter CRI 80, and Filter CRI 90. The 'Filter CRI 90' option is selected and highlighted in blue. Below the list is an 'Add Filter' button. On the right, the configuration for the selected filter is displayed:

- Name:** Filter CRI 90
- Color:** 0.319271, 0.315553, 68.093115
- SPECT:** A spectral graph showing Energy vs. Wavelength (nm) from 360 to 525. The graph shows a peak at approximately 440 nm with an energy of about 0.08.
- At 100 %:** A checkbox that is currently unchecked.
- Physical:** 100
- Transmission:** 68.1
- Interpolation To:** Linear

At the bottom of the interface, it says 'GDTF 1.1 Builder' on the left and '© GDTF 2021' on the right.

To help to understand the benefit to the user workflow and cooperation, see for example [this OnLocation special](#) with Veith Schmidt, where he talks about how teams can use this unifying format to work together without having to duplicate their work and effort.



In order to be able to do this level of coordination and cooperation Veith Schmidt is talking about, we [provide](#) comprehensive GDTF files for our devices. The Robe GDTF files library is [available through the GDTF Share](#). Our files include a lot of technical data which is needed to organize and control devices in any kind of event.

# WE PROUDLY SUF

# X GDT'

We have been ensuring that every new product that we release is accompanied with a complete, comprehensive GDTF file. Here is an example of the initial description for [FORTE®](#):

**Manufacturer** ⓘ

Robe Lighting

**Name** ⓘ

Robin FORTE

**Long Name** ⓘ

ROBIN FORTE™

**Short Name** ⓘ

FORTE

**Type ID** ⓘ

8FD3403C-C7B2-44CA-AD7E-DFB7FB88B656

**Linked GDTF** ⓘ

Linked GDTF

UUID

**RDM Manufacturer ID** ⓘ

5253

**RDM Device Model ID** ⓘ

0111

The data inside the GDTF file provide many details, including...

Device description like name, RDM ID for identification by controllers, power consumption, picture, 2D vector image for planning tools, weight, power consumption and many more data, required for planning and pre-show calculations:

**Operating Temperature Low** ⓘ

0



°C

**Operating Ten**

40

**Weight** ⓘ

39.8

**Leg Height** ⓘ

9

3D model is provided in a way that clearly identifies each part of the device, including the base, cable connection panel, yoke, head and also for example the lens or lenses of the fixture, which, in case of for example the Spider or Tarrantula, allows for very nice, realistic visualization.

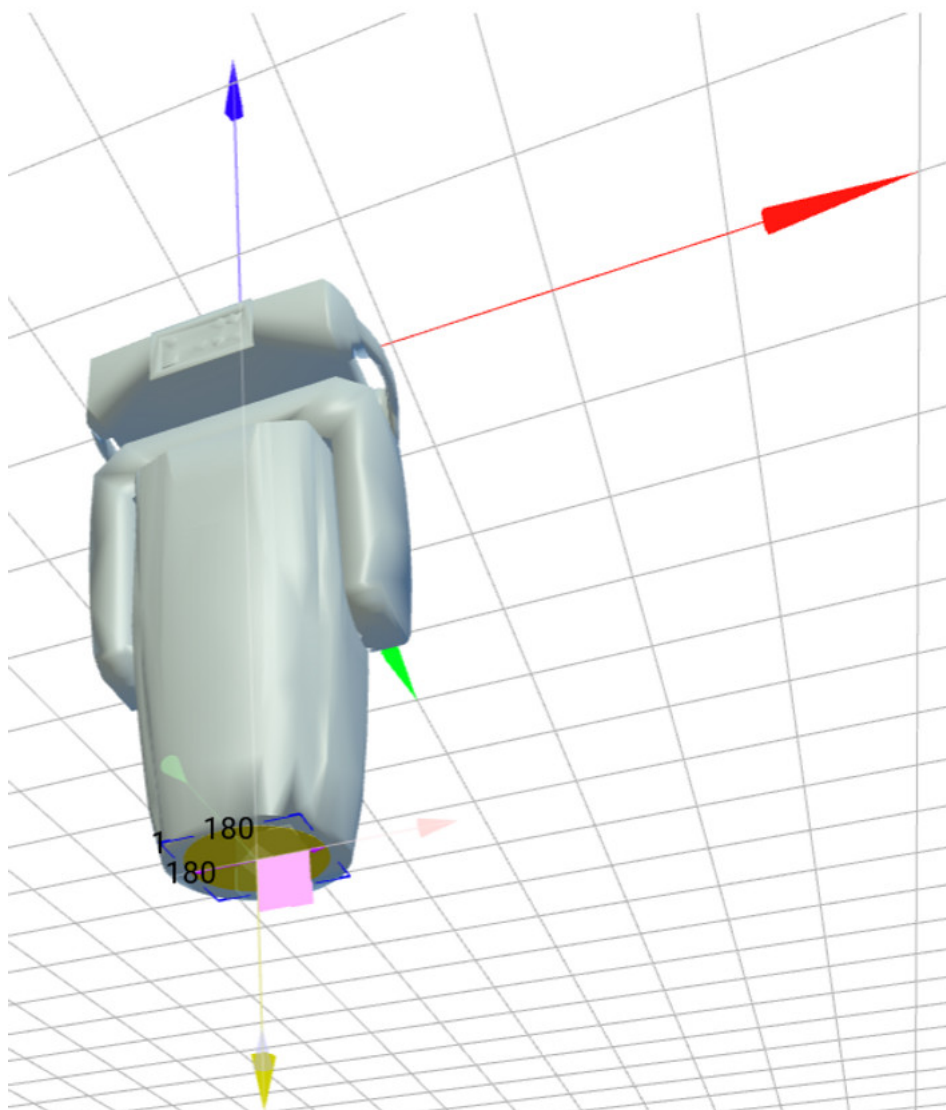

DMX description contains all DMX modes, their identification via RDM and also their description for the operator, to be able to understand which DMX Mode is most suitable for their mode of operation.

# DMX Modes

▼ **Mode 1 - Standard 16 bit** v0001->0001

- 1, 2** Yoke\_Pan
- 3, 4** Head\_Tilt
- 5** Base\_PositionMSpeed
- 6** Base\_Control1
- 7** Base\_LEDFrequency
- 8** Base\_LEDFrequencyAdjust
- 9** Base\_IntensityIndication
- 10, 11** Head\_Color1
- 12, 13** Head\_Color2

Included Color spectral power distribution data for lamps, LEDs, color flags and color wheels allow the controller to calculate DMX values for a particular color which a lighting designer is requesting. This also provides the possibility to select a desired spectral settings to not only achieve the perfect color but also it's spectral characteristic. This further allows to combine many fixtures of various manufacturers on a single stage and achieve the same color output from all devices (given that they provide GDTF with the spectral power distribution).

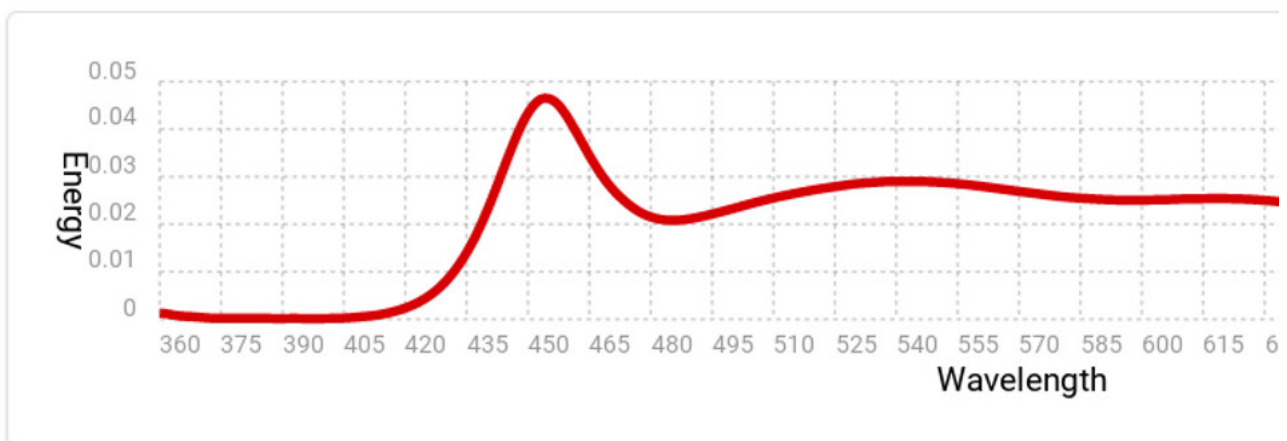

Graphics content of the GDTF files is including for example gobo images but also definitions for animation wheels, prisms and other effects.

▼ GoboWheel1	▼ GoboWheel2	▼ Color wheel :
1 Open	1 Open	1 Open
2 G01	2 G01	2 Deep red
3 G02	3 G02	3 Deep blue
4 G03	4 G03	4 Orange
5 G04	5 G04	5 Green
6 G05	6 G05	6 Congo blue

The data contains many more details, for example speeds of movements or strobing frequencies, zoom ranges and so on.

This year, we have had many additions to our Robe GDTF files library ([available here](#)), including [iBar 15™](#), [CUETE®](#), [T2 Fresnel™](#), [T2 PC™](#), [iPointe65®](#), [FORTE®](#), [FORTE® FS](#), [iParFect 150™ FW RGBW](#), [iSpiider®](#) or [DL4X Spot™](#).

If there is a fixture for which we do not provide a GDTF file or if you find an error in any of our files, feel free to contact us at a dedicated email address [libraries@robe.cz](mailto:libraries@robe.cz) , we are more than happy to create new files or provide support for existing ones.

The screenshot shows the 'Physical Descriptions' tab in the GDTF Builder software. On the left, a list of filters is shown, with 'Filter CRI 90' selected. The main panel displays the following settings:

- Name:** Filter CRI 90
- Color:** 0.319271, 0.315553, 68.093115
- SPECTRAL DISTRIBUTION:**
  - At 100 %: +
  - Physical: 100 (DMX %)
  - Transmission: 68.1 (%)
  - Interpolation To: Linear

Below the settings is a spectral distribution graph showing Energy vs. Wavelength. The x-axis ranges from 360 to 780 nm, and the y-axis ranges from 0 to 0.08. The graph shows a broad spectrum with a peak around 450 nm and smaller peaks around 525 nm and 600 nm.

At the bottom of the interface, it says 'GDTF 1.1 Builder', '© GDTF 2021', and 'Language en Help v1.5.2'.

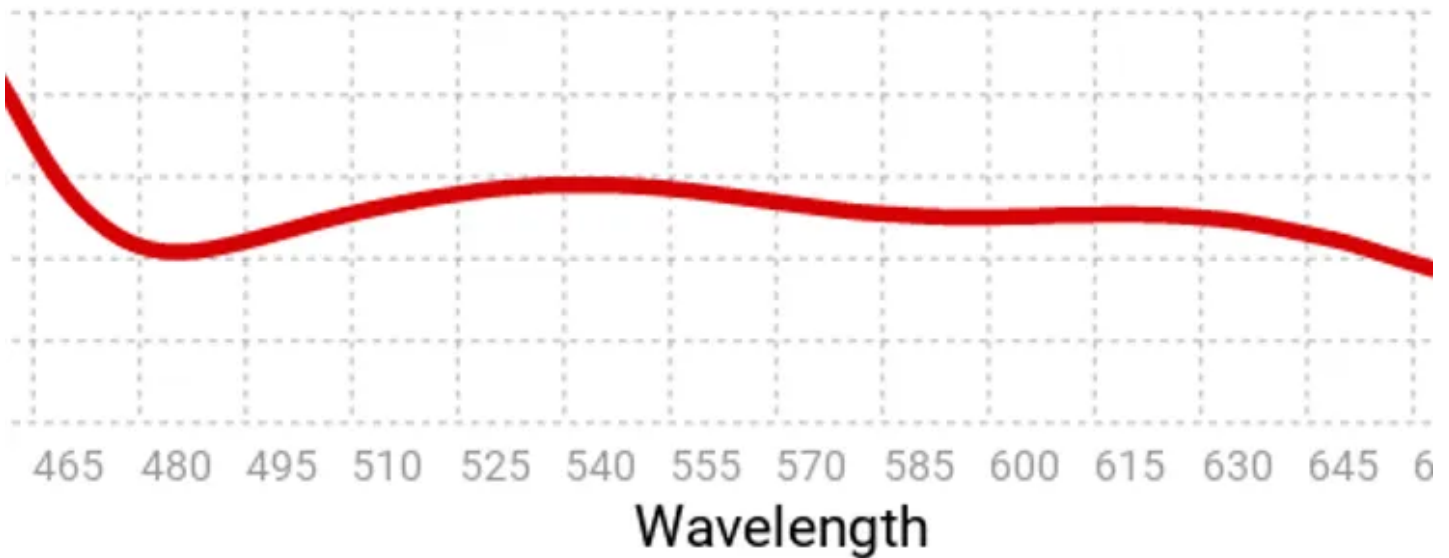

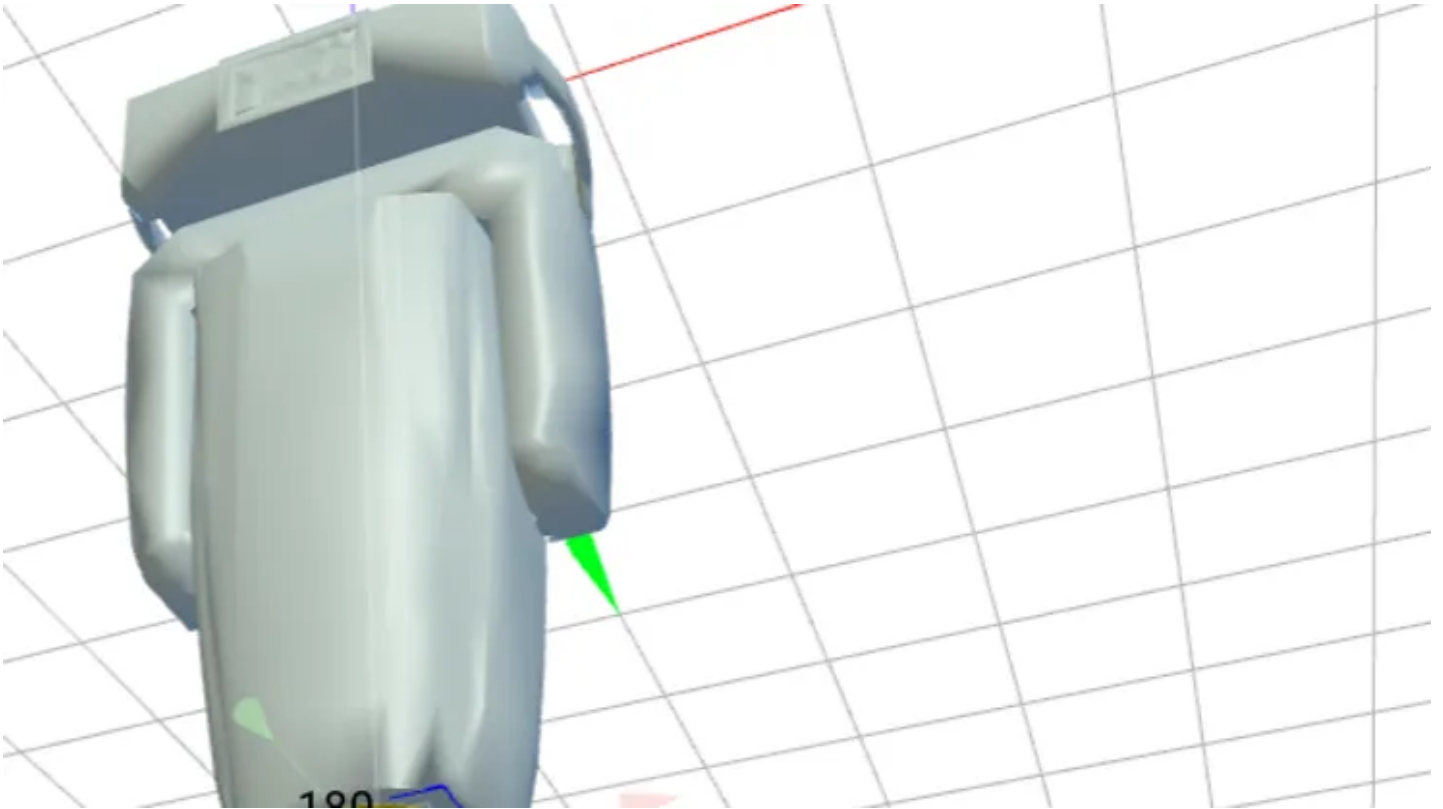

ature Low ⓘ



°C

Operating Temperature High

40





Robe Lighting

**Name** ⓘ  
Robin FORTE

**Long Name** ⓘ  
ROBIN FORTE™

**Short Name** ⓘ  
FORTE

**Type ID** ⓘ  
8FD3403C-C7B2-44CA-AD7E-DFB7FB88B656 

**Linked GDTF** ⓘ  
Linked GDTF 

**RDM Manufacturer ID** ⓘ  
5253







**RDM Device Model ID** ⓘ  
0111





WE PROUDLY SUPPORT



▼ **Mode 1 - Standard 16 bit** v0001->0001  

- 1, 2 **Yoke\_Pan** 
- 3, 4 **Head\_Tilt** 
- 5 **Base\_PositionMSpeed** 
- 6 **Base\_Control1** 
- 7 **Base\_LEDFrequency** 
- 8 **Base\_LEDFrequencyAdjust** 
- 9 **Base\_IntensityIndication** 

Wheel 1	▼ GoboWheel2	▼ Color wheel 1	▼ Color wheel 2
Open	 <b>1 Open</b>	 <b>1 Open</b>	 <b>1 Open</b>
G01	 <b>2 G01</b>	 <b>2 Deep red</b>	 <b>2 Multicolor</b>
G02	 <b>3 G02</b>	 <b>3 Deep blue</b>	 <b>3 Laser green</b>
G03	 <b>4 G03</b>	 <b>4 Orange</b>	 <b>4 Lavender</b>
G04	 <b>5 G04</b>	 <b>5 Green</b>	 <b>5 Filter Cyan</b>
G05	 <b>6 G05</b>	 <b>6 Congo blue</b>	 <b>6 Filter Purple</b>